

Anais table.

Accessories

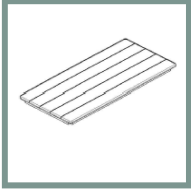

TABLE TOP
1 PIECE

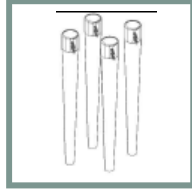
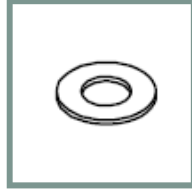

TABLE LEGS
4 PIECES



8 PIECES
M8



8 PIECES
M12

Instructions

STEP 1

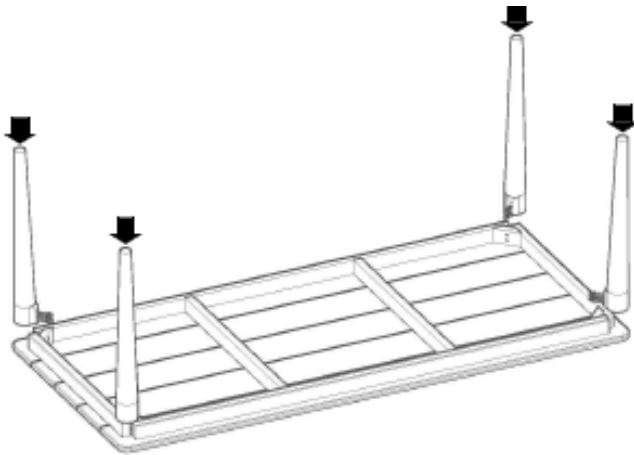

STEP 2

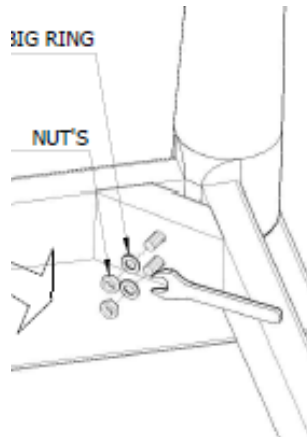

STEP 3

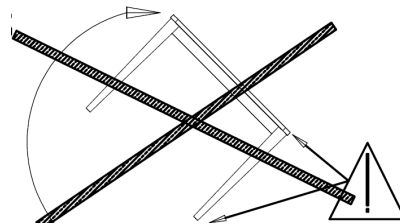
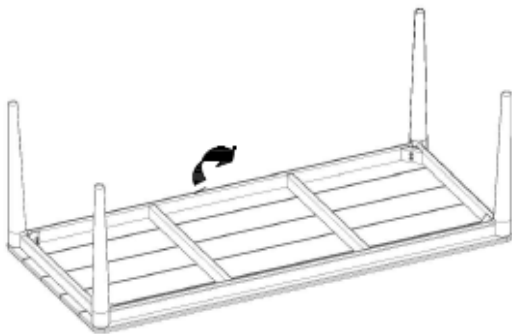

Always lift up the table to turn it over!
Never turn the table over leaning on one of its legs!

